

FR0x-400

RECEIVER

INSTRUCTION MANUAL

YAESU MUSEN CO., LTD.

TOKYO JAPAN.

FR_DX-400
COMMUNICATION
RECEIVER



YAESU MUSEN CO., LTD.

TOKYO JAPAN.

GENERAL:

The model FR-DX-400 Communication Receiver together with its accessories is designed to be used for SSB, CW, AM or FM reception on amateur bands in the frequency range from 1.6 Mc to 148 Mc. A citizen band (27 Mc) may also be covered as well as WWV.

Basically, it is a double conversion superheterodyne (triple conversion for VIIF bands) receiver employing crystal controlled high frequency oscillators, highly stable variable oscillator tuning the same range linearly on all bands and for selectivity, the MECHANICAL FILTERS and T-notch filter at the 455 Kc IF stage.

A precise instrument type double gear driven dial together with an adjustable scale on the main tuning dial knob provides easy and accurate frequency readings on all bands within approximately 1 Kc.

The receiver provides a wide variety of operations, such as rejection tuning, slow/fast AVC time constants, squelch circuit, crystal controlled operation, monitor circuit, and a 100 Kc/25 Kc calibrator.

The receiver can be used as a transceiver in conjunction with our FL-DX-SSB Transmitter.

SPECIFICATIONS

() option

Operating range1.7—2.3 Mc, 3.5—4.1 Mc, 6.9—7.5 Mc, 13.9—14.5 Mc, 20.9—21.5 Mc, 27.9—28.5 Mc, 28.5—29.1 Mc, (26.9—27.5 Mc, 29.5—30.1 Mc, 9.9—10.5 Mc)
ModeSelectable SSB and CW with ring demodulator, AM with diode detector; (FM with ratio detector)
SensitivitySSB, CW 0.5 uv S+N/N 10 db, AM 1.0 uv S+N/N 10 db
Selectivity1 Kc at 6 db down, 4 Kc at 60 db down with rejection tuning: 2.4 Kc at 6 db down, 4 Kc 60 db down: 4 Kc 6 db down, 7.5 Kc at 25 db down: (600 cps at 6 db down, 1.5 Kc at 60 db down)
Spurious responses—60 db at 14 Mc: Internal spurious signals within amateur bands less than that from a 1 uv antenna signal.
Frequency stabilityAfter warm up, less than 100 cps for any 15 minutes: less than 100 cps for 10% line voltage change.
T-notch rejectionBetter than 50 db.
Dial calibration1 Kc.
Antenna impedance50—75 ohm unbalanced.
Audio outputAt @ 5% distortion, more than 1 watt at 4/600 ohms.
Power consumption50 watts, 100/110/117/200/220 or 234 volts 50/60 cps
Dimensions6 ¹ / ₂ " H, 14 ¹ / ₂ " W, 11 ¹ / ₂ " D
WeightApproximately 25 lbs.

BLOCK DIAGRAM

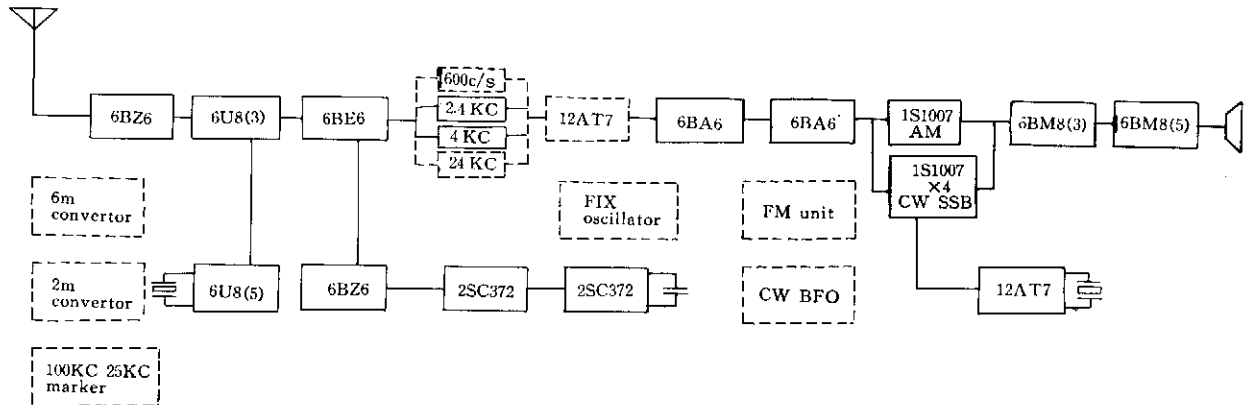

Fig. 1

PRINCIPLES OF OPERATION

The block diagram provides you with a better understanding of this receiver. Double conversion is adopted with injection voltage for the first mixer provided by a crystal controlled oscillator. A tunable IF of 500 Kc range is used to couple the first and second mixer. Injection voltage for the second mixer is provided by a Variable Frequency Oscillator with a tuning range of 500 Kc ganged to tunable IF tuning capacitors. The 455 Kc output frequency is coupled through second IF stage to separate AM, SSB, and FM detectors. Injection voltage to the product detector is provided by a crystal controlled BFO.

RF AND MIXER CIRCUIT:

A signal from the antenna passes through a trap coil which minimizes interference caused by the signals in the first IF range to the tuned circuit, and is applied to the control grid of the RF amplifier tube, V101, 6BZ6. The tuning capacitor for RF amplifier and first mixer is ganged and linked to the preselector tuning knob on front panel. The required tuning range of these tuning circuits for band spread are obtained by switching appropriate values of fixed capacitance in parallel with coils. The amplified signal from V101 is coupled to the grid of V102A, 6U8, first mixer. The injection voltage from V102B, 6U8, is coupled to the cathode of V102A. The output signal from the first mixer is coupled through L110, tunable IF transformer (5354.5 Kc—5954.5 Kc) to the grid of the second mixer V103, 6BE6, with VFO injection voltage applied to the cathode of this tube.

SECOND IF AND DETECTOR CIRCUIT:

The output signal from the second mixer is connected either to one of four mechanical filters MF1, MF2, MF3, or MF4 (MF1 and MF4 not supplied). The mechanical filter MF2 is centered to

455 Kc with a pass band of 2.4 Kc, and is selected for SSB or narrow band AM reception, while MF3 with pass band of 5 Kc is selected for wideband AM reception. MF2 is selected for CW reception also when MF1 is not supplied. MF1 with pass band of 600 cps can be installed on the filter assembly board for better CW reception. MF4 with pass band of 24 Kc can be installed to improve skirt response for FM reception. Output from the filter assembly is amplified through V601B. The notch filter is composed of coil L 602 and capacitor VC601. The rejection notch occurs at the resonant frequency of this tuned circuit, and is centered at 455 Kc. The variable capacitor VC601 is linked to the rejection tuning control which allows the rejection frequency to be moved across IF pass band. Optimum Q and depth of notch is determined by the proper adjustment of potentiometer VR601. VC601 is so designed that shorts the filter circuit on the OFF position. Output from Q multiplier is then amplified through the second amplifiers V104 and V105, 6BA6s. The cathode of V104 is combined to the cathode of V101, and connected to RF gain control potentiometer, VR101.

S meter circuit is connected from B supply to the plate circuit of V105, 6BA6, of which the plate current is decreased by the application of AGC voltage to its grid circuit.

The output signal from IF amplifier is coupled to the ring demodulator circuit. It is also coupled to AM detector and AGC diode D101, 1S1007, and to FM limiter V501A, 6U8. BFO injection voltage is applied to the ring demodulator for CW and SSB reception.

OSCILLATOR CIRCUITS:

This receiver contains four oscillators. They are high frequency crystal oscillator, variable frequency oscillator, beat frequency oscillator, and 100 Kc crystal calibrator.

High frequency oscillator, V102B, 6U8 provides injection voltage for the first mixer. The crystal frequency is always 595.5 Kc higher than the lower edge of the selected band. The secondary winding of L112 couples injection voltage to the first mixer tube cathode circuit and furnishes a DC return to the ground for the first mixer.

The VFO utilizes two transistors, 2SC372s, one of which oscillates at the frequency of 4900 Kc to 550 Kc, and the other works as a buffer stage to prevent loading of the oscillator circuit. The output from the transistor buffer is coupled to the grid of V107, 6BZ6 which works as second buffer to prevent the loading by cable capacity when operated in transceiver service. Supply voltage for the oscillator is stabilized by a regulator consisting of zener diode D113 and resistor R147. The VFO output voltage from V107 is coupled to the first grid of second mixer, V103, 6BE6.

V108, 12AT7 is used for the BFO crystal oscillator, and the injection voltage is supplied to the ring demodulator through L117. One of either cathode circuits is connected to the ground by the MODE switch for appropriate sideband operation. For CW reception, BFO oscillator is also selected by the MODE switch to reduce the interference caused by near-by signal.

These crystals provide the proper BFO frequency relationship to the mechanical filter pass band to generate optimum audio response from the ring demodulator.

The crystal calibrator circuit provides marker signals at multiples of 100 Kc, by FUNCTION switch at CAL 100 Kc position. At 25 Kc position, marker signals are generated by a multivibrator for accurate calibration between 100 Kc marker points. Variable capacitor TC301 provides for adjustment zero beat with WWV. The output signal from the circuit is coupled to the receiver antenna circuits.

CONTROL CIRCUITS:

Signal voltage is coupled from L115 to a diode D109 and D100, rectified to produce automatic gain control voltage. Generation of AGC voltage is delayed until the signal voltage at the diode exceeds the bias voltage determined by R148 and R157. C187, when switched into the circuit, presents a longer RC time constant allowing for a smoothly developed AGC signal. The AGC voltage is applied to the control grid of the RF amplifier and IF amplifier tubes.

Manual control of RF gain is accomplished by changing the cathode bias for RF amplifier and first IF amplifier tubes. A voltage divider circuit consisting of resistor R104 and RF GAIN control is connected across the B plus voltage line. At the maximum gain setting, this circuit produces proper operating bias for the RF and first IF amplifier tubes.

At lower control settings increased bias is provided which reduces the gain. The DC return of the RF and first IF amplifier tubes is connected through the RF GAIN control to the MUTE terminal. The MUTE terminal is connected to MONITOR control and FUNCTION switch S101C.

When the FUNCTION switch is placed in the REC position, a ground of the MUTE terminal causes the receiver to operate in a normal manner. At STBY position, DC return is made through MONITOR Control VR106. At the maximum setting of this control, MUTE terminal is connected to the ground to provide the DC return. At the proper settings of the MONITOR controls, the receiver gain recovers to monitor transmitter signals. The lowest settings of the MONITOR control produces cutoff bias to RF and first IF tubes, thus muting the receiver.

Rectified DC voltage from D101 is coupled through R507 to the grid of squelch control tube V501B, 6U8. V501B is so biased by VR105 that the tube is cutoff when signal is not received.

When the rectified DC voltage to the grid exceeds the cutoff bias, V501B conducts and provides DC return for the cathode circuit of the first audio amplifier tube V106A, 6BM8.

Lowest setting of SQUELCH control permit the receiver to operate in a normal manner.

AUDIO AND POWER SUPPLY CIRCUITS:

Audio voltage from the appropriate detector is selected by MODE switch, S103C and is coupled to the peak noise limiter circuit consisting of diodes D102 and D103. This limiter circuit is shorted by S104 when it is not used. Signal from the limiter circuit is amplified by V106A and coupled through AUDIO GAIN control, VR104 to the grid of V106B. Plate circuit of V106B is connected to an output transformer T101. Two audio outputs are provided. A 4 ohm output for the speaker, and a headphone jack is connected to the 4 ohm terminal. When the headphone is used, the speaker output is disconnected. A 600 ohm terminal may be used for antitrip output or phone patch.

The built-in power supply furnishes filament, plate, and transistor voltages for the receiver. The tube heaters and pilot lamps are connected in parallel, and the voltage is supplied from the 6.3 volt winding. Plate voltage is supplied by the full wave rectifier unit D111. Voltage for the transistors is supplied by the full wave rectifier unit D112, and stabilized by the zener diode, D113.

INSTALLATION

Before connecting the receiver to the AC line, examine for visible damage. If the receiver has been damaged in shipment, notify the agent to receive warranty repairs. Check tubes and crystals for proper seating in sockets, and check tuning controls and switches for freedom of action. The receiver power transformer can be operated on either 100/110/117/200/220 or 234 volts AC, check that the transformer connections (stamped on the rear apron of the chassis) are correct for the line voltage available.

Figure 2. shows the location of jacks, socket, and terminal for external connections to the receiver. J101 is a coax connector. J104 is an audio output terminal, and 4 ohm is for a speaker. Terminal marked "M" is for the mute circuit. To connect the receiver for mute operation, a means of shorting of M terminal to ground while receiving must be applied. Opening this M terminal mutes the receiver. A set of normally closed contacts on a relay which is keyed with the transmitter may be used for this purpose. To use this mute circuit, the receiver must be operated in the STBY position with MONITOR control at fully counterclockwise position. 600 ohm audio output may be used to supply antitrip voltage to the transmitter used together. The phone jack on the front panel is connected to the 4 ohm terminal, therefore, best results will be obtained if headphones used are of 4 to 16 ohms impedance. The speaker is disabled when the headphones are plugged in.

Figure 3 shows a complete station interconnection for a FR-DX-400 receiver, FL-DX-400 transmitter, and FL-DX-2000 linear amplifier. When the VFO output jack is connected to the transmitter for transceive operation, it may be necessary to adjust L116 to compensate for the detuning effect of the coaxial cable.

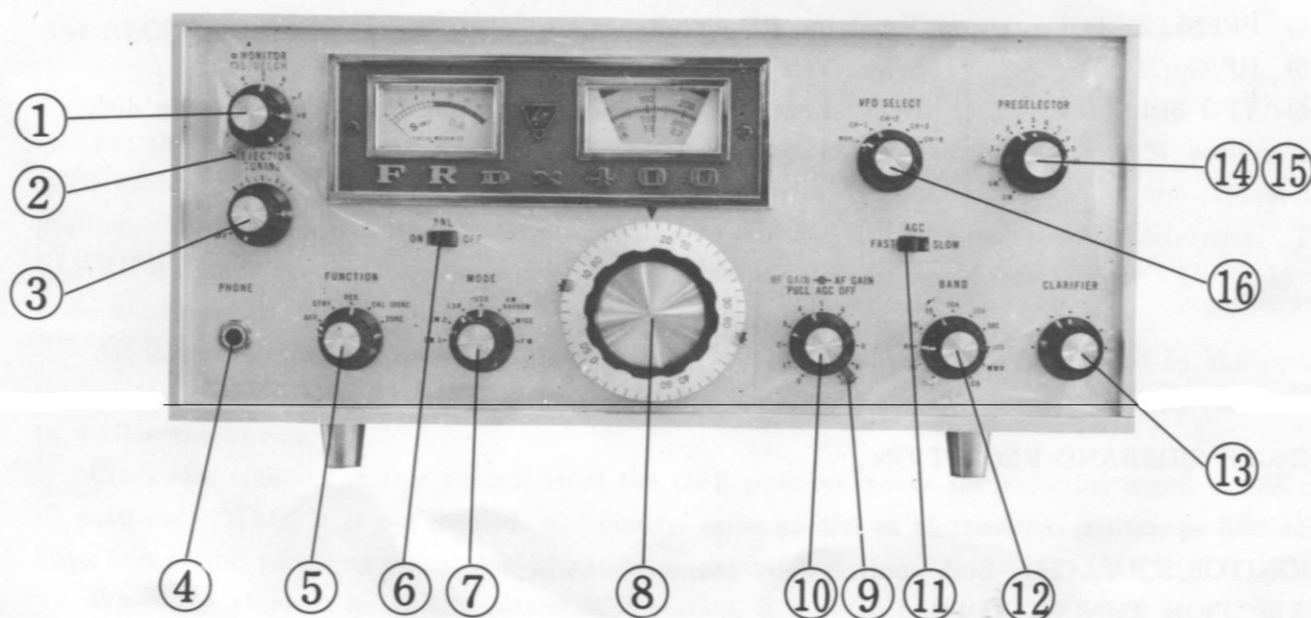

CONTROL FUNCTIONS:

- 1) MONITOR: Varies bias voltage to the receiver to monitor the transmitter signal.
- 2) SQUELCH: Determines squelch threshold.
- 3) REJECTION TUNING: Varies rejection frequency.
- 4) PHONE: Jack for headphones.
- 5) FUNCTION: OFF: Mains voltage is off.
STBY: All voltage applied to receiver.
REC: Receiver operates.
CAL 100 KC: 100 Kc calibrator is on.
25 KC: 25 Kc multivibrator is on.
- 6) ANL: ON: Automatic noise limiter is connected.
OFF: Noise limiter is disconnected.
- 7) MODE CW1/CW2: CW operation.
LSB/USB: SSB operation.
AM: AM operation.
FM: FM operation.
- 8) MAIN TUNING: Determines operating frequency.
- 9) RF GAIN: Controls the gain of RF and IF stages.
- 10) AF GAIN: Controls the gain of audio amplifier, and AGC voltage is shorted at pull position.
- 11) AGC: FAST: Fast release time constant.
SLOW: Slow release time constant.
- 12) BAND: Selects the coils and crystals for the desired band operation.
- 13) CLARIFIER: Varies the crystal frequency slightly for receiver incremental tuning.
- 14) PRESELECTOR: Tunes the RF circuits.
- 15) HF/6M/2M: Select VHF convertor used.
- 16) VFO SELECT: NOR: Receiving frequency determined by the main tuning dial.
CH1-CH4: Crystal controlled operation.

OPERATIONS

SINGLE SIDEBAND RECEPTION.

For SSB operation, set controls as follows;

MONITOR/SQUELCH: Both controls fully counterclockwise.

REJECTION TUNING: OFF.

FUNCTION: REC.

ANL: OFF.

MODE: Desired sideband.

RF/AF GAIN: RF gain control fully clockwise and AF gain to the 12 o'clock position.

AGC: SLOW.

BAND: Desired frequency band.

CLARIFIER: 12 o'clock position.

PRESELECTOR: For maximum noise or signal output.

VFO SELECT: NOR.

Tune in signal with the main tuning knob and adjust AF GAIN for desired audio output level. When listening to strong signals, RF GAIN control may be used to reduce set noise under no signal conditions.

Clarifier control may be used for a fine tuning of the main dial.

CW RECEPTION.

Set the controls as described in SSB reception, except a setting of the MODE switch to CW1 CW2. Center the desired signal in the receiver pass band, and then switch to the CW1 or CW2 mode depending on the location of interfering signals. Tune the upper side or lower side against the desired signal, to reduce interference. The clarifier can be used as a pitch control of the audio output signal. For breakin CW operation, the AGC control should be set to OFF position and the RF GAIN control decreased to prevent overload. Adjust the AF GAIN control to provide the desired audio output.

AM RECEPTION.

Set the controls as described in SSB reception. Set the MODE switch to AM position and AGC switch to FAST. High fidelity will be obtained with the MODE switch in the AM WIDE position. Under crowded band conditions, switch to AM NARROW to eliminate interference. The CLARIFIER can be used to select one of the sidebands having least interference. Under heavy noise conditions, ANL will be helpful in reducing the noise.

An interfering heterodyne or CW signal may be reduced in level or eliminated by the operation of the REJECTION TUNING control. At the OFF position, the tuning capacitor is shorted to disable the circuit.

Clockwise rotation of this control from the OFF position moves the rejection notch across the IF passband. When it is not needed, this control must be placed in the OFF position to avoid the distortion of the receiving signal due to narrower passband.

When the receiver is initially placed in operation, it may be necessary to touch up the adjustment section of this hand book.

TRANSCEIVE OPERATION WITH FL SERIES TRANSMITTER.

Connect the cables as shown in the illustration following page.

Set VFO select switch on FL-transmitter to TRANSCEIVE position.

Set the BAND switches to the same desired band and both MODE switches to the same position (either USB, LSB or CW).

Tune both receiver and transmitter as in normal operation. Both the transmit and receive frequency is controlled with the receiver VFO.

Due to the frequency tolerance of the HF heterodyne crystals, it may be necessary to adjust the CLARIFIER control to zero beat transmitting and receiving frequencies.

If the transmitted frequency is changed by any great amount, be sure to redip the PA plate current and check the loading. Do not attempt operation in transceive service with any other transmitter not having the same frequency mixing scheme as FL-transmitter.

For transceive service with FL-200-B transmitter in CW and USB modes, it is necessary to change the sideband crystal of the transmitter, from 8546.5 Kc to 8543.5 Kc.

Dial lock lever under the MAIN tuning knob is to adjust dial touch and it tightens the touch when rotated clockwise direction.

MAINTENANCE AND ALIGNMENT.

The FR-DX-400 receiver has been aligned and calibrated at the factory with proper test equipments and will not require realignment for a long period of operation. Service or replacement of a major components may require subsequent realignment, but do not attempt to make any adjustment unless the operation of the receiver is fully understood.

CABINET REMOVAL.

Disconnect all power and external connections, and remove two screws under the cabinet and six painted screws located at the front edge of the cabinet. From the rear, push the receiver chassis forward and slide the chassis and panel assembly out of the cabinet.

IMPORTANT: DO NOT LUBRICATE THE VFO GEAR ASSEMBLY.

ALIGNMENT PROCEDURE.

The alignment of the receiver can be accomplished using a signal generator and VTVM. However, complete alignment may be accomplished using the crystal calibrator as a signal generator and the S-meter as a peak indicator.

455 KC IF ALIGNMENT.

- a. Set MODE switch to USB, and center the calibrate signal at 14.2 MC in the IF passband. If the calibrator signal is stronger than the S-meter reading of S4, use a higher band such as the 15 or 10 meter band.
- b. Adjust the slugs of L114 and L115 for peak meter reading.
- c. If a signal generator is used for this alignments, unsolder C124 from pin 1 of V103, connect generator to pin 7 of V103, and adjust frequency to center of filter pass band. Align as described above, disconnect signal generator, and replace C124.

T-NOTCH FILTER ALIGNMENT.

- a. Check REJECTION TUNING knob position. It should be at the OFF position.
- b. Tune the receiver to the calibrator signal on a band which provides a signal level of approximately S-9 plus 20 db in either USB or LSB position. Center signal in IF passband.
- c. Set REJECTION TUNING knob to midscale (at 12 o'clock position).
- d. Alternately adjust VR601 and L601 for maximum depth of notch as indicated by minimum S-meter reading. If the circuit exhibits a tendency to ring or oscillate, back off slightly VR601.

TUNABLE IF ALIGNMENT.

- a. Set VFO frequency to 200 kc and tune the receiver to calibrator signal on a band which provides a signal level of approximately S3 in either USB or LSB.
- b. Adjust the slugs of L110 for peak S-meter reading.
- c. If a signal generator is used for this alignment, disable the heterodyne oscillator by removing the crystal for the band used. Connect the signal generator to pin 9 of V102, and set to 5,555 Kc. Tune the receiver to the generator signal at approximately 200 on the dial, and align as described above.

VFO DIAL CALIBRATION.

- a. Set the BAND switch to any band and function switch to CAL 100 KC, and tune the calibrate signal to zero beat at 500, on the higher end of the dial.
- b. Set the 50 KC subdial to 0/50 position while holding the dial knob firmly.

- c. Tune the dial to 0, lower end.
- d. Adjust TC105 slightly to zero beat.
- e. Tune the dial to 500 higher end, and adjust L113 slightly to zero beat to the calibrator signal.
- f. Repeat this procedures until the VFO is calibrated at both end.

BFO ALIGNMENT.

Connect a RF probe of the VTVM between the secondary of L117 and ground, and adjust the slug of L117 for maximum output. Back off slightly on the slug until the VTVM shows 70% of the maximum reading.

HIGH FREQUENCY OSCILLATOR ALIGNMENT.

Connect a RF probe of the VTVM between the hot end of the secondary of L112 and ground. Set the BAND switch to 10 D band, and adjust L112 for maximum VTVM reading. If the crystals are not equipped for the 10D band, do not touch L112. Change the BAND switch to lower bands and adjust the appropriate capacitors (TC103-TC104) for maximum VTVM reading.

RF CIRCUIT ALIGNMENT.

- a. Tune to the calibrator signal at 1.7 Mc with the MODE switch in either USB or LSB position. Connect a 47 ohm resistor or a dummy load to the antenna connector. Set the PRESELECTOR to 1 position. *ADJ - L 102 C 106*
- b. Tune to the calibrator signal at 3.5 Mc, and adjust slugs L103 and L107 for peak S-meter reading.
- c. Tune to the calibrator signal at 6.9 Mc, and adjust slugs L104 and L108 for peak S-meter reading.
- d. Tune the calibrator signal to 28.0 in 10 A band, and adjust slugs L105 and L109 for peak S-meter reading.
- e. Set the PRESELECTOR to center and tune the calibrator signal at 14.2 Mc, and adjust TC101a and TC-102a for peak S-meter reading.
- f. Tune the calibrator signal at 21.2 Mc in 15 meter band, and adjust TC-101b, and TC-102b for peak S-meter reading.
- g. Disconnect the dummy load from the antenna connector, and connect a signal generator; set signal generator to 5650 Kc with maximum output. Set the BAND switch to 40 meters, and PRESELECTOR to 0 position. Adjust trap coil L10 for minimum S-meter reading. Disconnect the signal generator.
- h. Connect an antenna to the antenna connector and tune to WWV and adjust TC-101C and TC-102C for peak S-meter reading.

S-METER ZERO ADJUSTMENT.

Set the receiver to the middle of any band, and peak the PRESELECTOR for maximum output. Set RF-GAIN control to maximum, and short antenna terminal. Adjust S-meter ADJ control on the rear apron of the chassis until the S-meter reads zero.

TROUBLE SHOOTING

Most cases of trouble can be traced to defective tubes. Substitution of new tubes will sometimes clear an obscure case. Intermittent trouble conditions in tubes can be usually be discovered by lightly tapping the tube envelope. Occasionally, tube socket terminals will become dirty or corroded causing intermittent condition. When this situation is suspected, remove the tube and apply a few drops of contact cleaner to the socket pins, and work tube up and down in the socket a few times. A logical process of elimination in conjunction with schematic diagram will aid in isolating troubles.

Attached tables show typical voltage and resistance readings at each tube socket terminal, and these are the best aid in trouble shooting. Bear in mind that any of these values will vary slightly due to line voltage and to normal tolerance in components and the measuring equipment used.

Following is typical cases of troubles and a trouble shooting guide.

TUBE AND DIAL LIGHT OUT : Blown fuse is probable case. Usually indicates short on the heater wiring, high voltage circuit, or silicon rectifier defective.

TUBES LIGHT BUT NO AUDIO : Check high voltage at filter condenser. If normal, check voltage of pin 6 and 9 of V106. Check headphone jack and speaker leads. Check diodes D-102 and 103. If OK this far, switch to AM detector and SSB detector. If one is OK but not the other, check the diodes in the detector circuit.

AUDIO OK BUT STILL NO OUTPUT ; For troubles in the RF and IF stages, you can use S-meter as well as audio to check troubles. Check on several positions of both band switch and mode switch. If the set works normally on some mode but not others, the trouble is confined to the filter assembly. If the set works normally on some bands but not on other, the troubles may be in RF amplifier, 1st mixer or x-tal oscillator. If its behavior is the same on all mode and bands it may be in either RF or IF stages. Touch pin 1 of V104 with VTVM lead tip. Should produce click from the speaker? Is this OK, troubles may be in RF stages. If this is not, troubles is in IF stages. Check V104 and V105. Check VFO injection voltage at pin 1 of V103 with RF probe. This is about 2 volts. Touch test lead to pin 1 of V103. Using this lead as an antenna, you

should hear noise. If not, check voltages of V103 and V107. If the noise does come up at this point, the troubles are in RF stages.

If the troubles are nearer the front end of the receiver than V103, you should be hearing some tube noise even if no signals. While listening to this noise, pull out V102 from socket. If this stage working normally, there should be a marked decrease in the noise. If there is not, check voltages in this stages. A test lead attached to pin 9 of V102 should bring in some of the stronger signal if the stage is working normally. In this case, troubles must be in RF amplifier stage.

This stage by stage technique should enable you to isolate the trouble in almost all case where the receiver is dead. If the complaint is lack of sensitivity though the set is still operative, a similar retracing from the audio stage back to front end should be used. Remember that troubles confined to one of two bands must be in V101, V102 or V103.

If the S-meter fails to read correctly check AVC circuit.

STATION INTERCONNECTIONS

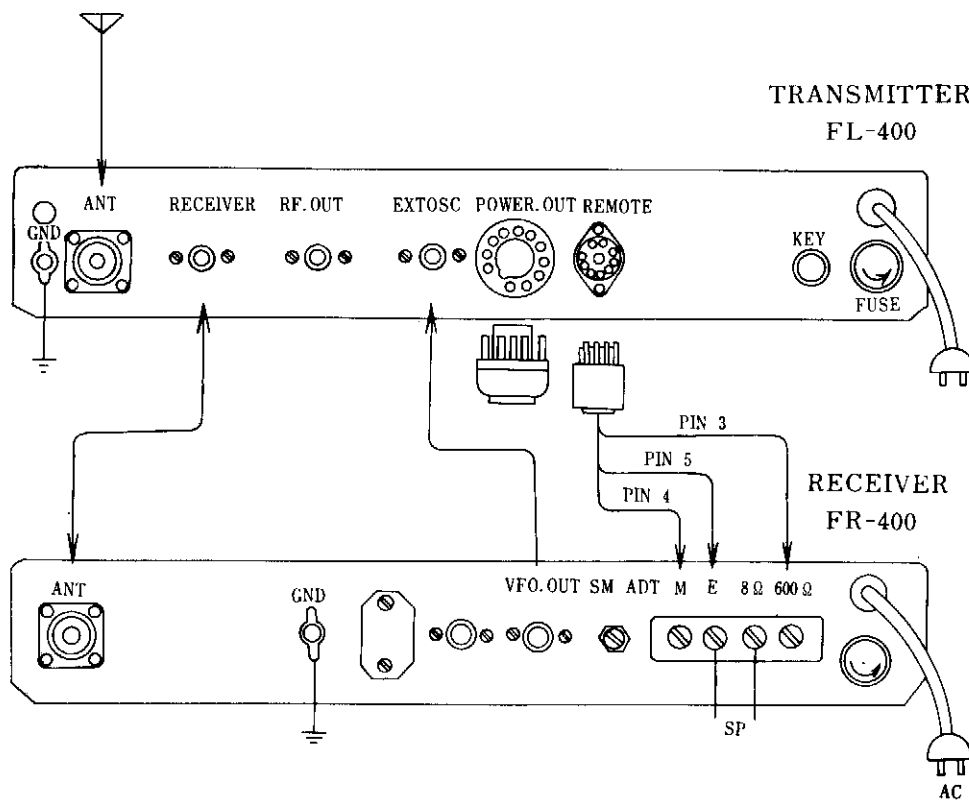

ACCESSORIES

FM DETECTOR UNIT

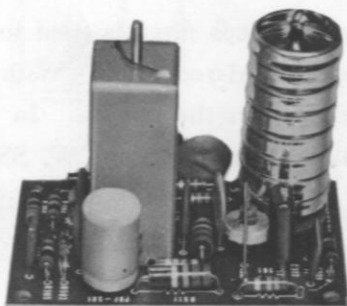

100KC/25KC MARKER

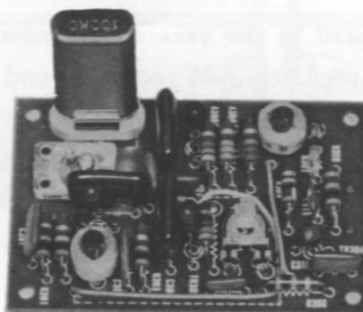

2 METER CONVERTOR

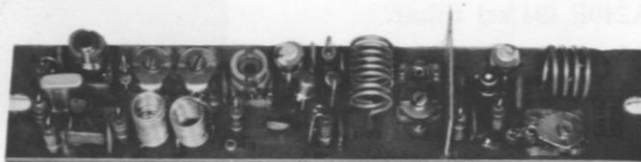

6 METER CONVERTOR



INSTALLATION OF OPTIONAL ACCESSORIES

Filters Installation;

Space is provided in the receiver to install accessory filters; 600 cps filter is used in CW reception, 6 kc filter is used for AM reception and 24 kc filter is used in FM reception. With the cabinet lid open, the printing board for the filters assembly can easily be seen on the chassis. In the original, MF455-10AZ (2.4 kc) and MFH40K (4 kc) are supplied. MF455-10AZ is used for CW, SSB, USB and narrow AM reception in original wiring. To install optional filters, few wiring modifications are necessary as illustrated in the figures. Be careful not to make mistake in installation of input and output transformers. Refer to the figure.

Installation of MF455-03AZ (600 cps) Filter.

Install filter and matching transformers on printing board and solder all pins to the printing board under the chassis. Cut short wire on mode switch and wire installed matching transformers to mode switch as illustrated.

Installation of MF455AO50F (5 kc) Filter.

Remove original filter, matching transformer and shorting string on the printing board, and install new filter and matching transformers. Solder all pins to the printing board under the chassis.

Installation of MF455A240F (24 kc) Filter.

This filter is used for FM reception. Remove short wire on the printing board and install the filter and matching transformers. Solder all pins to the printing board under the chassis.

Alignment;

Tune the receiver to marker signal and adjust the slugs of input and output matching transformer of appropriate filter for maximum S-meter reading.

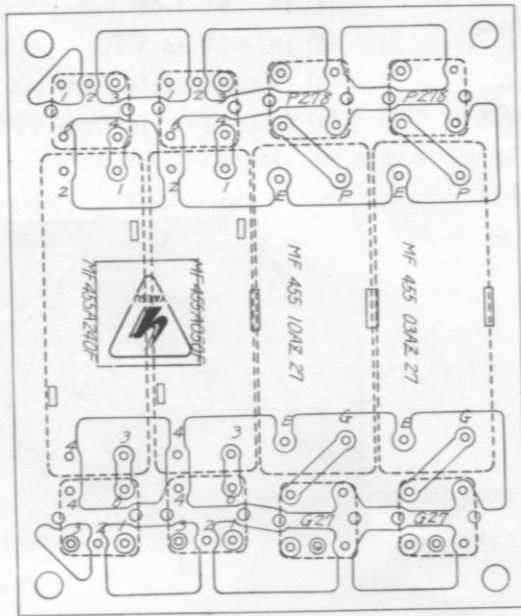

MODE SWITCH

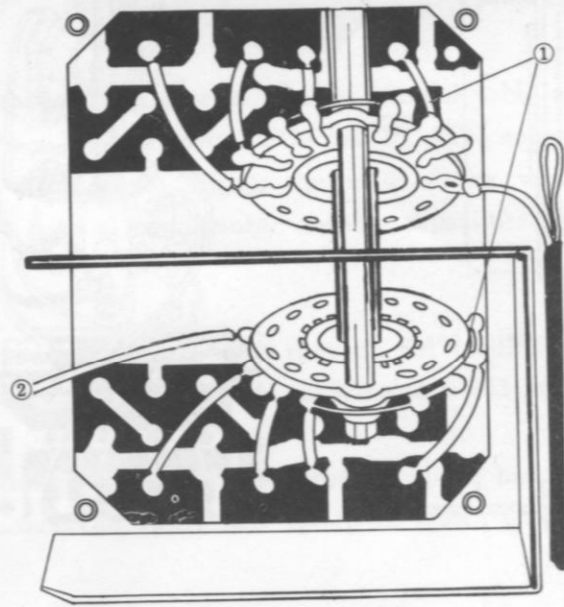

BOTTOM VIEW

- ① Disconnect shorting wire here
- ② Wired to C601



	600cps	5KC	24KC
Ⓐ input transformer	P278	Pink	Pink
Ⓑ output transformer	G27	Blue	Blue

Installation of FIX Oscillator Unit;

In original set, X-tal oscillator printing board for X-tal controlled operation is not supplied. Wire the printing board and switches illustrated in the figures, then install the printing board on the chassis with bracket supplied.

Alignment ;

Install crystals into the socket of printing board. Connect a RF probe to pin 5 of V107, and adjust slug of coil on the printing board for maximum VTVM reading. Trimmer capacitor on the printing board is used to slightly shift the frequency of the X-tal used.

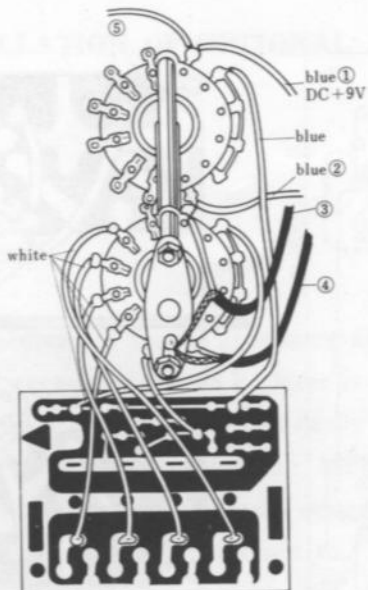
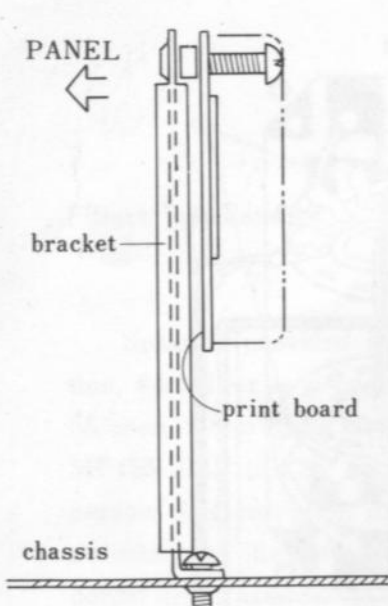

- ① DC+9V from power supply
- ② DC+9V to VFO
- ③ Coaxial cable from pin 1 of V107
- ④ Coaxial cable from VFO

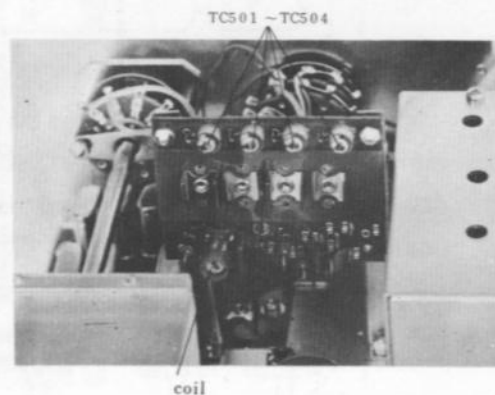

Installation of FM Unit;

Remove the cover on the opening in the chassis, install FM unit with screw on the chassis and wire as illustrated.

Alignment;

Connect signal generator to pin 1 of V103 and set to 455 kc. Set the mode switch to AM NARROW mode and adjust signal generator output for S 9.

Connect VTVM RF probe to pin 6 of V501, and adjust lower slug of L501 for maximum VTVM reading. Disconnect VTVM. Connect VTVM DC leads to the connection point of R506 47K and R512 1M ohms. Adjust upper slug of L501 for VTVM reading zero. Disconnect VTVM.

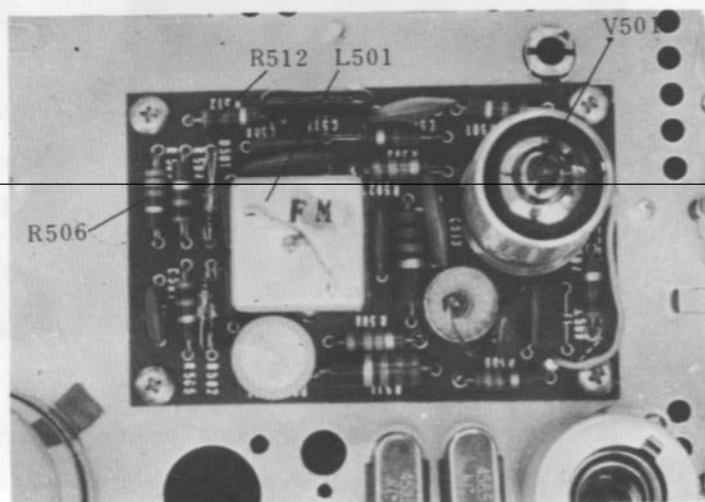
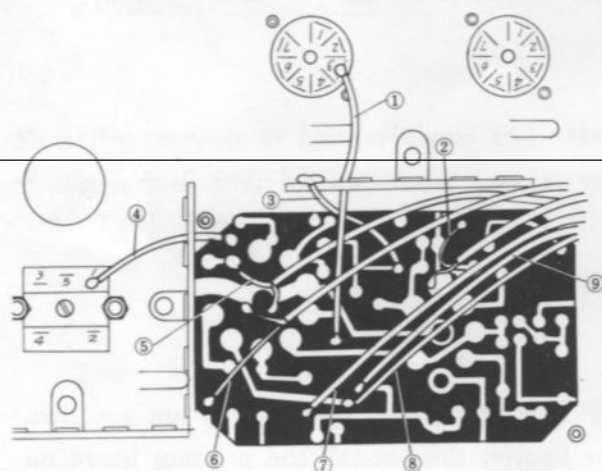

- ① blue wire to heater supply
- ② Shield wire (green) audio out put to S103C
- ③ brown wire to B supply
- ④ Red wire to L-115
- ⑤ Shield wire (red) to R136
- ⑥ Shield wire (white) to S103C
- ⑦ green wire to S103D
- ⑧ White violet to VR501
- ⑨ Violet to R137

Installation of VHF Convertor Units;

Fix the coaxial connectors to the hole in the bracket with screws. Solder coaxial cable and wires to the appropriate terminals in the printing board. Then install FC-6TR, FC-2TR convertors on the bracket as shown on the pictures of the following page. Solder the ends of the wires which have been soldered to the printing board to the coaxial connectors, variable capacitors and rotary switch as illustrated.

Alignment;

The units are so aligned with proper test equipment at factory that they do not require adjustment after installation. TC-802 and TC-902 are neutralizing capacitors. L-803 and L-903 are coils for local oscillators.

The units work in conjunction with 10 meter bands of the receiver, and 10 meter bands work as tunable 1st IF amplifier. The relation between receiving range and 1st IF is shown on the following table.

IF Mc	28.0	28.5	29.0	29.5	30	Local X-tal
6 meter	50.0	50.5	51.0	51.5	52.0	22 Mc
	52.0	52.5	53.0	53.5	54.0	24 Mc 24 34
2 meter	144.0	144.5	145.0	145.5	146.0	38.966 Mc × 3
	146.0	146.5	147.0	147.5	148.0	39.333 Mc × 3

The units are aligned for above frequency corresponding to the local crystal frequency. When you wish to change local crystal to cover another frequency range, trimmer capacitors and slugs should be adjusted for peak S-meter reading against incoming signal except above-mentioned neutralizing capacitors.

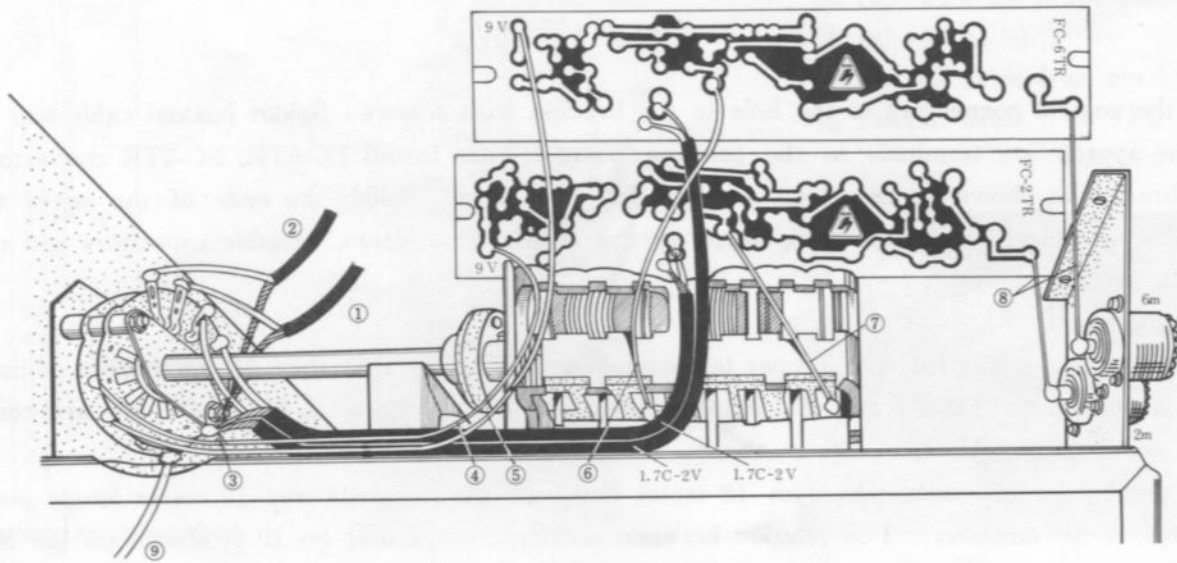

- | | |
|------------------------------------|-------------------------------------------------|
| ① From antenna connector | ⑥ to FD-6TR output tuning capacitor |
| ② To antenna trap coil | ⑦ to FC-2TR output tuning capacitor |
| ③ DC-9V supply to convertor FC-2TR | ⑧ antenna input to the convertors |
| ④ DC-9V supply to convertor FC-TR | ⑨ to VFO select switch DC-9V supply (blue wire) |

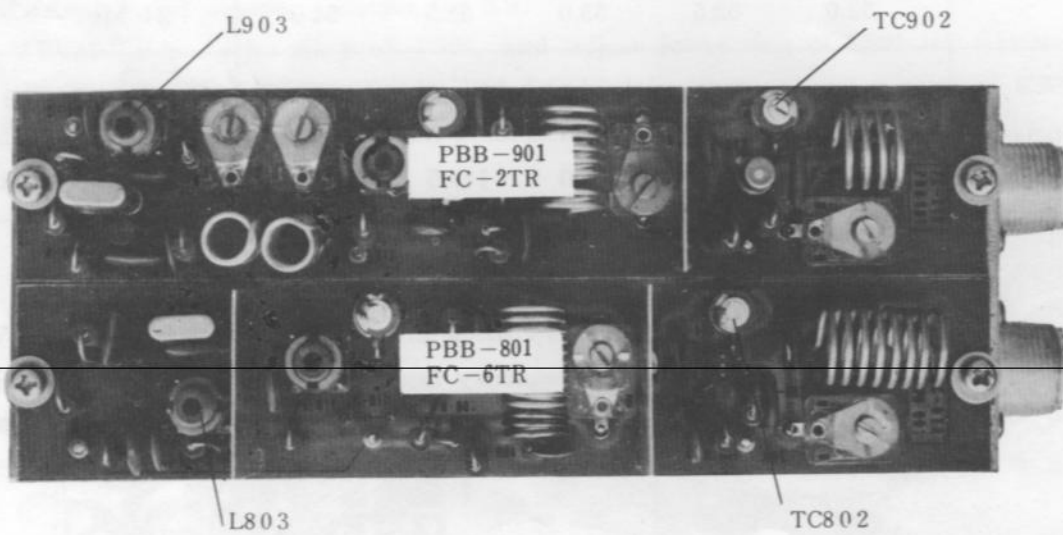

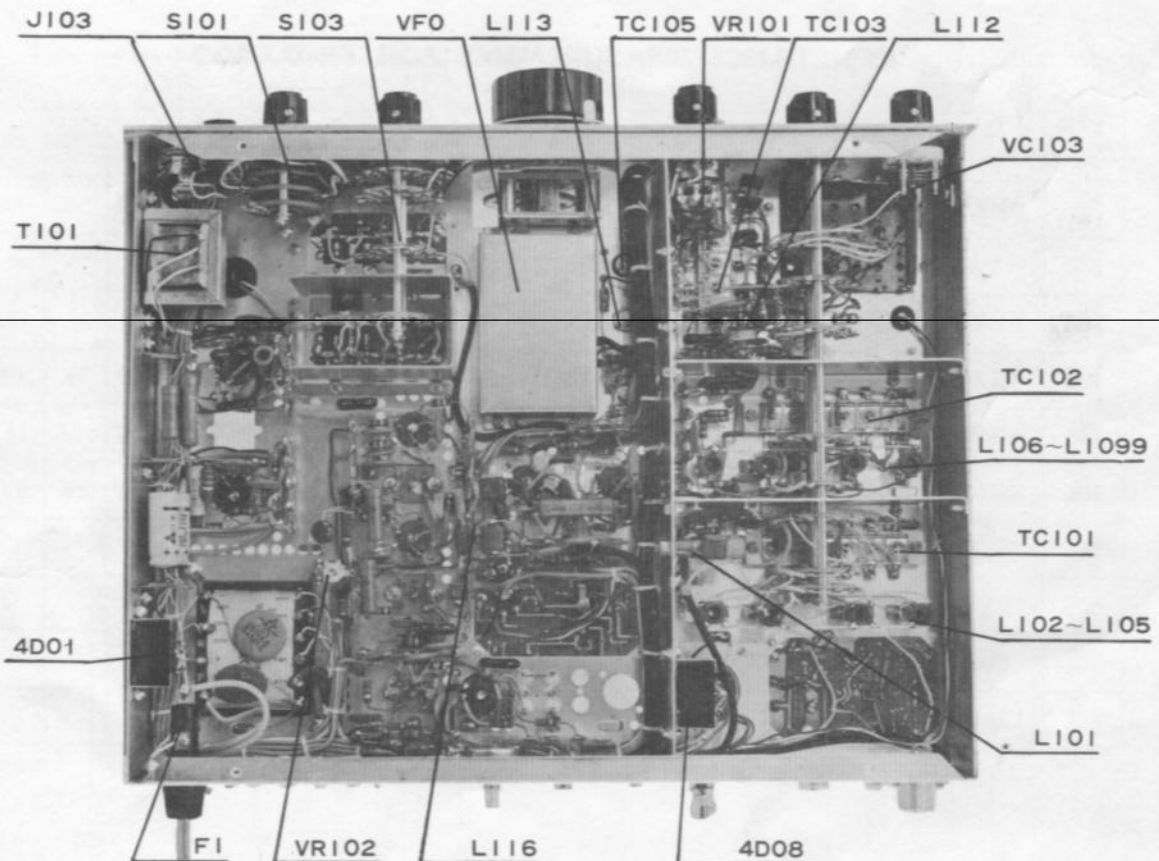
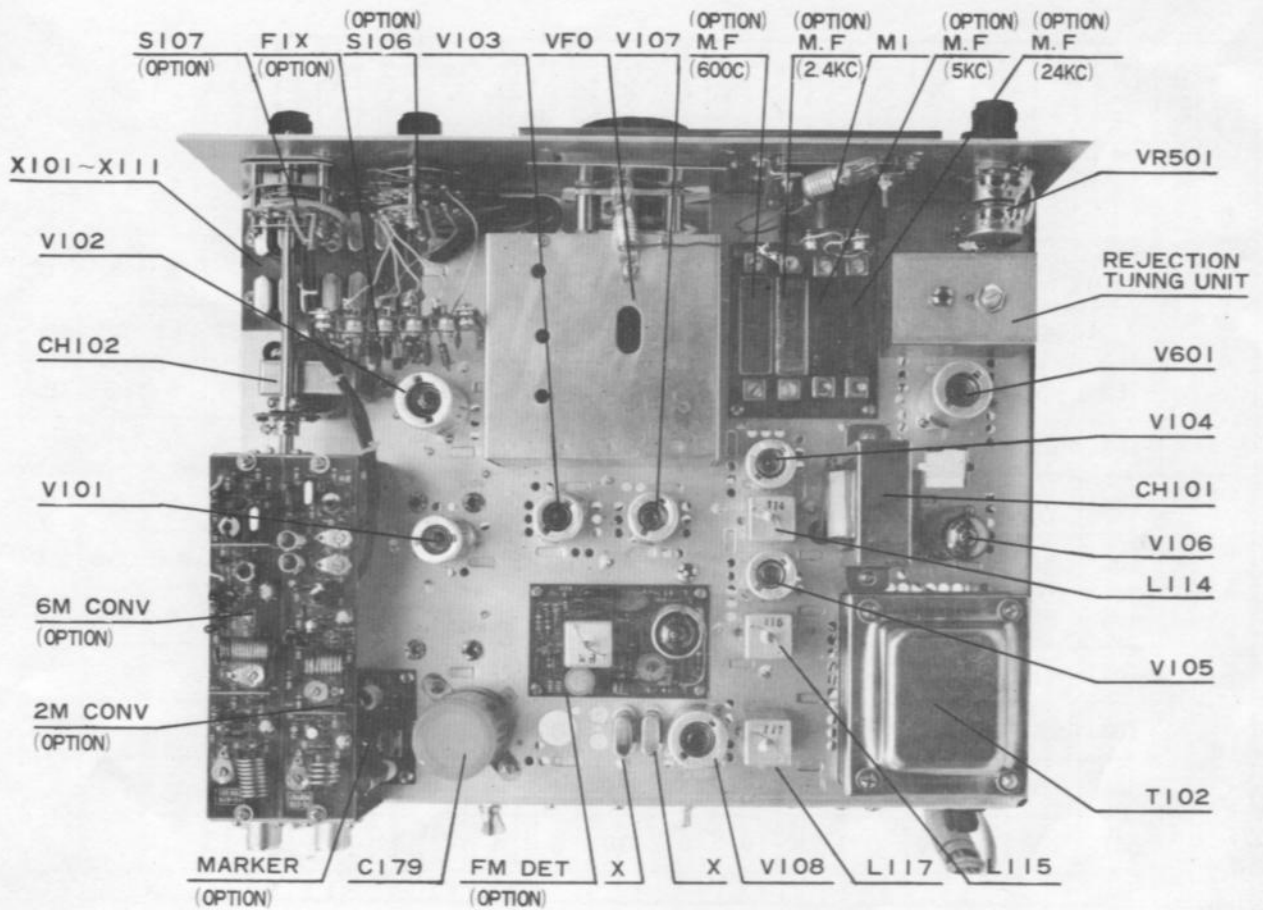

VOLTAGE MEASUREMENT FOR FR-DX400

TUBE \ PIN		1	2	3	4	5	6	7	8	9	TR \ PIN				
V 101	6BZ6	0	1.4	AC 6.3	0	200	90	0			TR 301	2SC367	0.1	9.5	0.1
102	6U8	205	0	145	AC 6.3	0	205	4	6.4	0	302	2SC367	0	5	0
103	6BE6	0	4	AC 6.3	0	195	95	0			303	2SC367	0	3	0
104	6BA6	0	0	AC 6.3	0	205	85	1.2			304	2SC367	0	9.8	0
105	6BA6	0	0	AC 6.3	0	200	85	1.2			401	2SC372	2.8	9.6	2.6
106	6BM8	80	15	0	AC 6.3	0	200	210	105	175	402	2SC372	4	9.6	4.6
107	6BZ6	0	1.4	AC 6.3	0	200	95	0							
108	12AT7	140	0	1.6	0	0	140	0	6	AC 6.3					
501	6U8	95	0	205	0	AC 6.3	210	16	10	0					
601	12AT7	210	0	3.4	0	0	210	0	4	AC 6.3					

RESISTANCE MEASUREMENT FOR FR-DX400

TUBE \ PIN		1	2	3	4	5	6	7	8	9	TR \ PIN				
V 101	6BZ6	∞	150	0	0	10K	15K	0			TR 301	2SC367	470	5K	10K
102	6U8	6K	50K	30K	0	0	6K	470	1K	200K	302	2SC367	0	∞	∞
103	6BE6	20K	500	0	0	20K	30K	0			303	2SC367	0	∞	∞
104	6BA6	∞	0	0	0	6K	15K	100			304	2SC367	100	5K	10K
105	6BA6	∞	0	0	0	6K	10K	100			401	2SC372	560	50K	1K
106	6BM8	∞	200	500K	0	0	5K	5K	20K	150K	402	2SC372	560	2K	2K
107	6BZ6	200	100	0	0	6K	60K	0							
108	12AT7	30K	50K	470	0	0	30K	50K	∞	0					
501	6U8	300K	100K	500K	0	0	40K	0	50K	∞					
601	12AT7	5K	10K	1K	0	0	5K	10K	2K	0					

FR-DX-400 PARTS LIST

Part No.	Description	Value	Notes
108, 110, 111, 114, 123	C-CAPACITOR	500WV	
125, 126, 127, 128, 129	D I S C	220K	1/2W
144, 148, 149, 150, 151		22K	1/2W
152, 156, 157, 158, 161		470	1/2W
164, 165, 167, 168, 173	R-RESISTOR	30K	5W
176, 180, 183, 185, 190		10K	1/2W
191, 192, 193, 194, 195		30K	3W
101, 124, 171		500P	500WV
102, 112, 138		±10%	F.M.
103, 113, 146, 147, 153		100P	500WV
154, 175, 182, 200		±10%	F.M.
104, 115, 159, 172, 184		250P	500WV
105, 116		350P	500WV
108, 120, 130, 134, 179		1000P	500WV
118, 131, 133, 135, 155		20P	500WV
119, 122, 142		±10%	F.M.
121		30P	500WV
134, 198		10P	500WV
137		70P	500WV
139		7P	1J
140		CERAMIC	
141		7P	UJ
143		0.05μ	50WV
160		3000P	500WV
162, 163, 186		±10%	F.M.
166		10μ	25WV
168		10μ	25WV
177, 178		200μ	25WT
179		100μ	350WV
181		470P	500WV
187		1μ	15WV
188, 189		0.01μ	1.4KV
101, 104, 120, 125	R-RESISTOR	100K	1/2W
102, 136		150	1/2W
103		100	1/2W
105, 119, 122, 123, 126, 143		100	1/2W
106, 108, 109, 114, 117		1K	1/2W
124, 145, 146		220K	1/2W
107, 135		22K	1/2W
110, 118, 153		470	1/2W
111, 116, 150, 151		30K	5W
112, 188		10K	1/2W
115, 131, 144, 149, 152, 154		30K	3W
128, 142		1.5K	1/2W
129		100K	1W
130, 148		470K	1/2W
132, 155		2.2M	1/2W
133, 134, 156		4.7K	1/2W
137, 141		56	1/2W
147, 159		2.2K	1/2W
157		20P	
101	VC-VARIABLE CAPACITOR	(430P + 18P) × 2	18P × 2
102		15P × 3	
103		20P	
101, 102, 103	TC-TRIMMER CAPACITOR		30P × 6
104		10P × 2	
106		10P × 2	
101, 105, 106	D-DIODE	1S1007	
102, 103, 110	SD-1Y SILICON		
104	IS225 SILICON		
109	IS180 SILICON		
111	4D-08 SILICON		
112	4D-01 SILICON		
113	SH-1 SILICON		
201	MF-MECHANICAL FILTER	MF 455-10Z	
202		MFH 40K	
201	T-TRANSFORMER		
202			
201	ELECTROLYTIC		
201	ELECTROLYTIC		
202	ELECTROLYTIC		
101, 107	CH-FILTER CHOKE	5H 140mA	
102		1H 50mA	
101, 107	V-VALVE	6RZ 6	
102		6U 8	
103		6BR 6	
104, 105		6HA 6	
106		6U 8	
108		1 2 A T 7	
101, 104, 120, 125	R-RESISTOR	100K	1/2W
102, 136		150	1/2W
103		100	1/2W
105, 119, 122, 123, 126, 143		100	1/2W

Part No.	Description	Value	Notes
101, 103, 104, 105, 107	VS-VALVE SOCKET	7P	
102, 106, 108		9P	
101	VR-VARIABLE RESISTOR	10KC	500KA
102		10KB	
103		10KB	
104		50KB	100KC
105		MRA-48	
106			250μH
107			
108			
109			
110			
111			
112			
113			
114			
115			
116			
117			
106	C-CAPACITOR	1000P	500WV
107		±10%	F.M.
108		50P	500WV
109		±10%	F.M.
110		470P	500WV
111		±10%	F.M.
112		100P	500WV
113		±10%	F.M.
101	S-SWITCH	RS-3.4.5	
102		RS-8.8.1.1	
103		RS-4.4.7	
104, 105		MS-1.0.2.1	
106		RS-2.4.5	
105		RS-1.2.3.V.C.	
101	F-FUSE	1A	GLASS
101, 308	R-RESISTOR		10K 1/2W
302, 309			100K 1/2W
303, 310			100 1/2W
305, 307			4.7K 1/2W
304			33K 1/2W
306			22K 1/2W
301	TC-TRIMMER CAPACITOR		50P
301, 302, 303, 304	TR-TRANSISTOR		2SC367
301	VR-VARIABLE RESISTOR		10KB 1/2W
301, 302	L-INDUCTOR		4MH
301	D-DIODE		1S1007
301	X-CRYSTAL		HC18/U 100KC
301	XS-CRYSTAL SOCKET		HC6/U TYPE

301	XF-CRYSTAL HOLDER	HC6U	TYPE	701	L-INDUCTOR
	PB-PRINTED BOARD	PBC-301		701	PB-PRINTED BOARD
	C-CAPACITOR *	1000 P 500W V	±10% F.M.	402, 407, 408	C-CAPACITOR
601, 603, 604		0.01 μ 500W V	DISC	401	200P 500W V
602, 605, 608		620P 500W V	DISC	403, 406	1000P 500W V
		±10% F.M.		404	400P 500W V
	R-RESISTOR	10K $\frac{1}{2}$ W			±10% F.M.
601		2.2K $\frac{1}{2}$ W			R-RESISTOR
603		100 $\frac{1}{2}$ W		404, 407	560 $\frac{1}{2}$ W
604		1K $\frac{1}{2}$ W		405, 406	3.3K $\frac{1}{2}$ W
605		56 $\frac{1}{2}$ W		401	1K 1W
606		220 $\frac{1}{2}$ W		402	4.7K $\frac{1}{2}$ W
607		3.3K $\frac{1}{2}$ W		403	1.5K $\frac{1}{2}$ W
	V-VALVE	12AT7		408	100K 1W
601					TR-TRANSISTOR
	VS-VALBE SOCKET	9P		401, 402	2SC372
601				401	L-INDUCTOR
	VC-VARIABLE CAPACITOR	20P		402	RFC
601				401	RFC
	VR-VARIABLE RESISTOR	20KB $\frac{1}{6}$ W		401	PB-PRINTED BOARD
601					C-CAPACITOR
	L-INDUCTOR	1MH		502, 503, 513	0.01 μ 500W V
601				504, 505, 508	200P 500W V
	C-CAPACITOR	0.01 μ 50W V	DISC	508, 509	100P 500W V
701		±10% F.M.		501	±10% F.M.
704		100P 500W V		507	50P 500W V
	R-RESIS TOR	33K $\frac{1}{2}$ W		511	1000P 500W V
701		3.3K $\frac{1}{2}$ W		512	±10% F.M.
702		470K $\frac{1}{2}$ W		510	0.05 μ 50W V
703		10 $\frac{1}{2}$ W			DISC
704					ELECTROLYTIC
	TC-TRIMMER CAPACITOR	20P F		501, 504, 505	100K $\frac{1}{2}$ W
701, 702, 703, 704				507, 512	1M $\frac{1}{2}$ W
	TR-TRANSISTOR	2SC372		502, 508	470K $\frac{1}{2}$ W
701				510, 511	22K 1W
	D-DIODE	1S145		503	22K $\frac{1}{2}$ W
701				506	47K $\frac{1}{2}$ W
				509	270K $\frac{1}{2}$ W
				501, 502	D-DIODE
					1S1007

501	V-VALBE	6L8
501	VS-VALBE SOCKET	S-B1330-2
501	L-INDUCTOR	RFC 250 μ II
501	PB-PRINTED BOARD	PBF 501

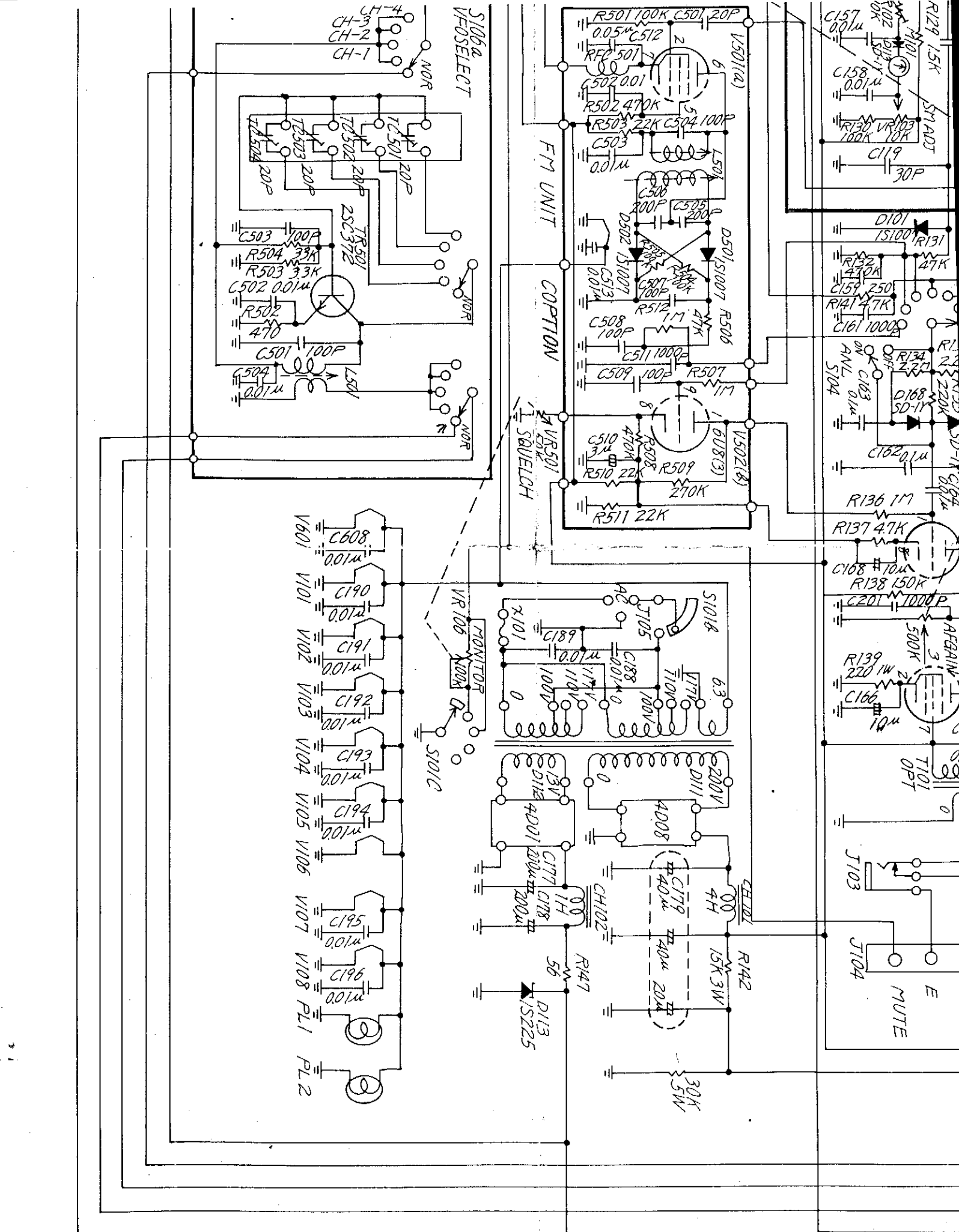

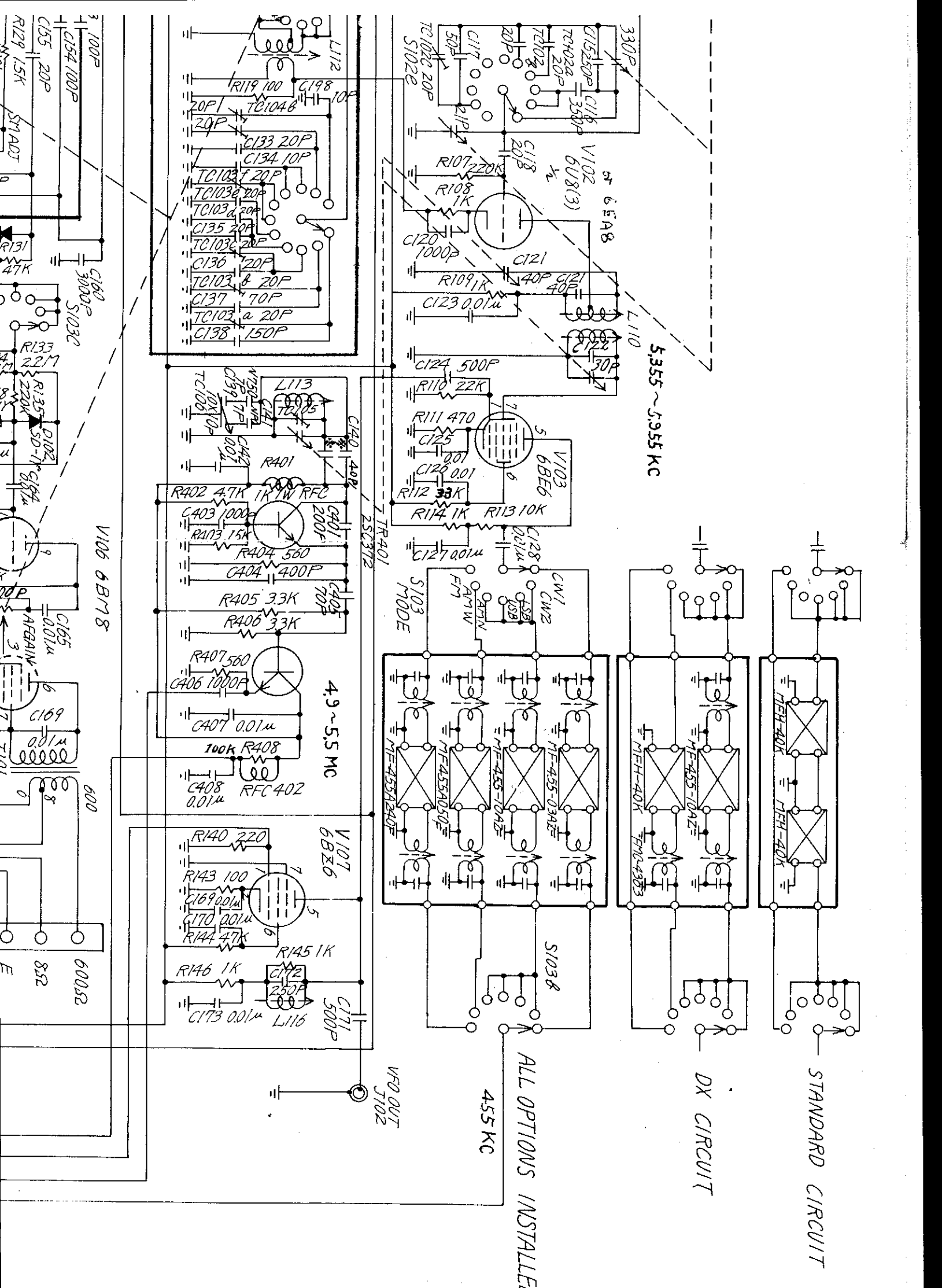

K4XL's **BAMA**

This manual is provided **FREE OF CHARGE** from the “BoatAnchor Manual Archive” as a service to the Boatanchor community.

It was uploaded by someone who wanted to help you repair and maintain your equipment.

If you paid anyone other than BAMA for this manual, you paid someone who is making a profit from the free labor of others without asking their permission.

You may pass on copies of this manual to anyone who needs it. But do it without charge.

Thousands of files are available without charge from BAMA. Visit us at <http://bama.sbc.edu>